

- ^{ぶんどき}分度器の中心を点アに合わせて次の角度をかきましょう。

1 300°

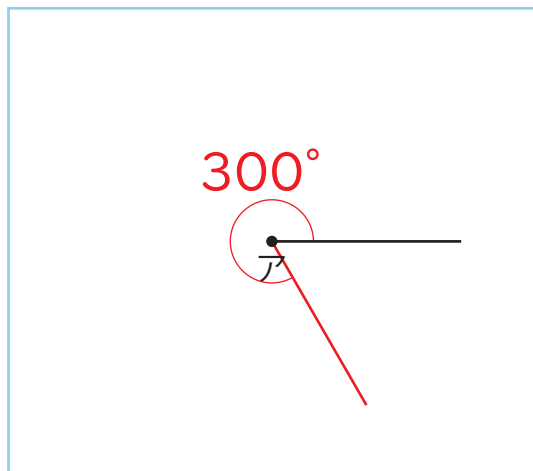

2 270°

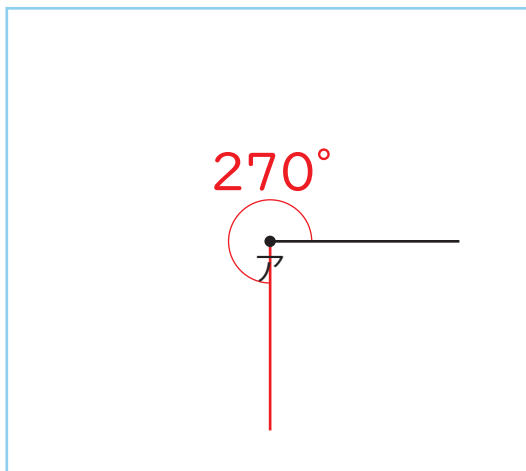

3 210°

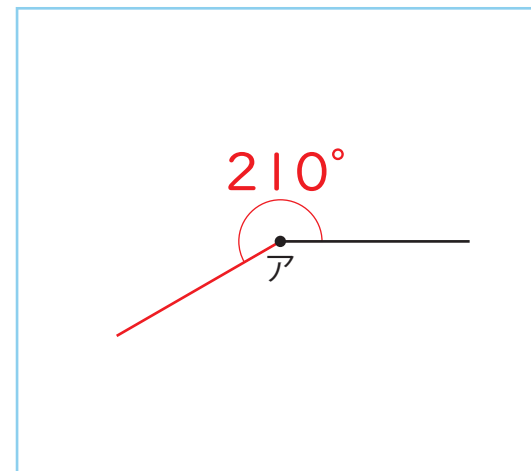

4 190°

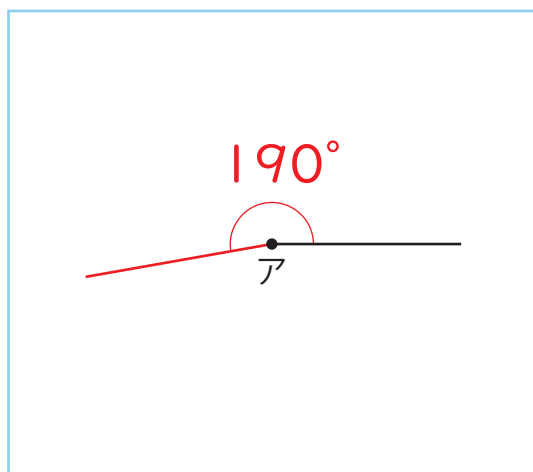

5 250°

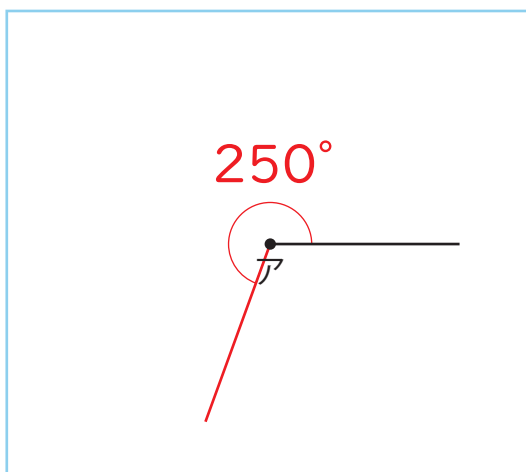

6 320°

